



I S A V

**Journal of Theoretical and Applied
Vibration and Acoustics**

journal homepage: <http://tava.isav.ir>



A new multi-switch circuit with adaptive capacitance for semi-active piezoelectric shunt damping

Saber Mohammadi, Akram Khodayari*, Salar Hatam

Mechanical Engineering Department, Razi University, 6714967346, Kermanshah, Iran

ARTICLE INFO

Article history:

Received 31 May 2019

Received in revised form
5 August 2019

Accepted 23 October 2019

Available online 11 November
2019

Keywords:

Vibration damping,

Electronic semi-active damper,

Piezoelectric,

Electrical resonance.

ABSTRACT

Piezoelectric-based shunt dampers are developed in recent years because of simplicity in comparison with other methods. In these methods, a part of converted mechanical energy is stored in the internal electrostatic field of the piezoelectric and a minor portion is dissipated in the load resistor of damping circuits. In recent methods, the electrostatic field of piezoelectric elements is reduced (not eliminated) and a portion (not whole) of the stored energy is extracted and dissipated in the resistor. In this paper, using a new adaptive multi-switch network and RLC resonance concept, the electrostatic field of piezoelectric is eliminated (not reduced) and almost the whole converted energy (not a portion) is extracted and dissipated in the load resistor. Using the proposed network, self-tuning ability provides electrical resonance in the circuit for almost all excitation types in a wide frequency band and also any mass and stiffness of the structure. Most of the electronic damping techniques are presented just for harmonic excitations, but the proposed technique in the current work is suitable for both harmonic and random excitations. In mechanical structures with variable mass such as vehicles, airplanes and missiles, structure mass will be changed while motioning. For such systems, resonance frequencies will change by structure mass during operation. Recent RLC dampers are not self-tuning for different mechanical stiffness or mass, but, the proposed technique is completely adaptive with variable mechanical characteristics of the vibrating structure. Consequently, significant damping is obtainable in comparison with other electronic damping techniques.

© 2019 Iranian Society of Acoustics and Vibration, All rights reserved.

* Corresponding author.

E-mail address: a.khodayari@razi.ac.ir (A. Khodayari)

Nomenclature

l	beam length	α_i	piezoelectric macroscopic coefficient
b	beam width	c_{11}^E	piezoelectric Young's modulus in x axis under constant electric field
N	modes number	ϵ_{33}^S	piezoelectric permittivity in y axis under constant strain
$u(x,t)$	displacement	d_{31}	piezoelectric strain constant
Φ_i	eigenmode functions	S_i	circuit i th switch
$q_i(t)$	beam modal coordinates	C_i	circuit i th capacitor
$f(t)$	excitation function	L	circuit inductor
M_i	generalized mass for the i th mode	R_L	load resistor
K_i	generalized stiffness for the i th mode	X_C	reactance of circuit capacitors
c_i	damping for the i th mode	X_L	reactance of circuit inductor
T	vibration period	C	equivalent circuit capacitance
A_u	displacement damping	ω	frequency (rad/s)
A_p	piezoelectric surface area	f	frequency (Hz)
t_p	piezoelectric thickness	n	circuit switches number
h_p	distance from the centroid of piezoelectric to the neutral axis	S_C	controller parameter of switches in binary form
l_p	piezoelectric length	T_0	digital oscillator period
v^p	piezoelectric global voltage	(f_{min}, f_{max})	frequency range of circuit operation
I_{out}	piezoelectric outgoing current		
C_p	piezoelectric capacitance		
R_p	piezoelectric resistance		

1. Introduction

Smart materials with special electromechanical behavior are recently used for active vibration suppression, such as fluid damper [1] piezoelectric damper[2], shape memory alloy [3] and eddy current damper [4]. In active vibration control, smart materials play two different sensing and actuating roles. Smart sensors extract the vibration characteristics of the structure and smart actuators suppress vibration at suitable moments. In recent years, by using electronic circuits, many new practical and useful ideas for vibration suppression are developed which are known as electronic vibration dampers with competitive characteristics [5, 6]. However, using various electronic elements, microcontrollers programming, logical processing unit design, etc. increases methods complication, but the stability and robustness of electronic control methods are considerable.

In a shunt vibration damper as an important category of vibration dampers, an electrical impedance is connected to the smart material. Shunt vibration controllers are developed in recent years because of competitive characteristics and remarkable damping than previous techniques. [7]. One of the most famous categories of shunt damping is piezoelectric shunt damping (PSD) [8]. The piezoelectric element is attached to a mechanical vibrating structure and produces an electric voltage with the same frequency of the vibration signal. Piezoelectric electrodes are connected to a shunt circuit to dissipate electric voltage. Indeed, the piezoelectric element extracts vibration energy of the structure, converts it to electrical energy and the shunt circuit dissipates the extracted energy. Therefore, the kinetic energy of the structure is decreased and vibration amplitude is controlled. The most simple shunt damper contains a single resistor which dissipates electrical energy and controls vibration. Advanced shunt dampers are more complicated and have more electronic elements, such as capacitors, inductors, etc. Using these elements besides modified electronic network, adaptive shunt dampers are obtainable [8].

In general, shunt damping techniques are classified into three categories of passive, active and semi-active approaches. This classification is based on energy requirements. Passive shunts mainly consist of several resistors and need no external energy to damp vibration. In active shunts, an external energy source is required to suppress vibration. In semi-active classes, the vibrating structure energy is used to control its own vibration. Shunt dampers are widely studied and developed in recent years by many researchers because of valuable advantages rather than traditional approaches. Earlier studies were developed by Wu [9], in which passive shunt dampers containing load resistors were considered. Tsai and Wang[10] and Morgan and Wang [11] introduced a combination of PSD vibration dampers with the Active Noise Control (ANC) method with modified characteristics. Date *et al.*[12] developed an active PSD method to control the elastic properties of the piezoelectric material in a wide frequency range, which was used by Kodama *et al.* [13] in order to noise control. Mokry' *et al.* [14]. presented the theoretical analysis of the mentioned systems. New applications of active elasticity control to noise and vibration suppression were developed by many researchers [15-17]. In recent years, the PSD technique is strongly considered to noise and vibration control problems. [18-20].

Recent RLC shunt dampers using piezoelectric elements are designed mainly based on mechanical structure resonance frequencies. These circuits are designed to resonate in each mechanical natural frequency. If excitation frequency is equal to the resonance frequency, displacement signal is single-frequency and harmonic and mentioned circuits provide significant damping. But, when a multi-modal mechanical structure is excited by complex random forces, system displacement is composed of some harmonic signals with inherent mechanical natural frequencies of the system and RLC damper performance will be disturbed. Also, they are not adaptive and should be tuned in a new mechanical situation of the structure. In mechanical structures with variable mass such as vehicles, airplanes and missiles, structure mass will be changed while motioning. A considerable portion of ballistic missiles mass is because of the fuel and detachable parts. After missile launching, structure mass will be decreased gradually and terminates the target with minimum mass. For such a system, resonance frequencies will change by structure mass during operation. Recent RLC dampers are not self-tuning for different mechanical stiffness or mass of the structure during operation and don't have acceptable performance.

To cover weaknesses of earlier RLC shunt dampers, a new semi-active adaptive RLC shunt damper using piezoelectric materials is proposed in this paper. This circuit is designed as a multi-modal vibration damper to control any type of vibration such as harmonic, random, etc. The proposed circuit consists of a series of switch-capacitor sets and also an inductor connected to a vibrating piezoelectric. Using the proposed network, self-tuning ability provides electrical resonance in the circuit for almost all excitation types in a wide frequency band and also any mass and stiffness of the structure. Therefore, electrical resonance occurs in any operational situation and almost the whole converted energy by piezoelectric element is extracted from the piezoelectric electrostatic field and is dissipated in the resistor. Consequently, significant damping is obtainable in comparison with other PSD techniques. In the following, the proposed method is modelled and numerical results show good performance in vibration control.

2. Electro-mechanical modeling

The proposed damping method consists of piezoelectric patches mounted on a vibrating mechanical structure in which their electrodes have been connected to a multi-switch circuit with an equivalent adaptive capacitor, an inductor and a load resistor. The simplified schematic model of the proposed system is shown in Fig. 1 that consists of separated mechanical and electrical parts with coupled governing equations. The considered mechanical structure is a cantilever beam with lateral motion and an external excitation at the free end. The differential equation for lateral motion of the beam with electrical shunt damping and also the global voltage and outgoing current of the piezoelectric element attached to the cantilever beam are presented in Eqs. (1) and (2) (Guyomar *et al*) [21].

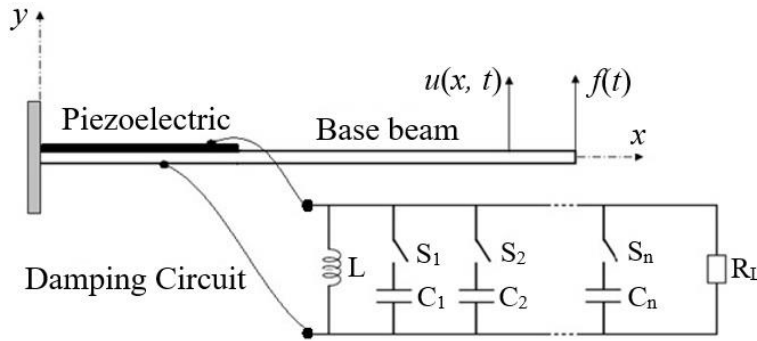

Fig. 1. Schematic of the multi-switch damping system.

$$M_i \ddot{q}_i + c_i \dot{q}_i + K_i q_i = \phi_i(l) f(t) - \alpha_i v_i^p(t) \quad (1)$$

$$v^p = \frac{1}{C_p} \sum_{i=1}^N \alpha_i q_i(t) I_{out} = \sum_{i=1}^N \alpha_i \dot{q}_i(t) - C_p \dot{v}^p \quad (2)$$

In these equations M_i , K_i and c_i are the generalized mass, stiffness and damping for the i th mode of the beam, respectively. ϕ_i , $f(t)$ and l are eigenmode functions, excitation function at the free end and the beam length.

$q_i(t)$, C_p and α_i are the modal coordinates, capacitance and macroscopic coefficient of the piezoelectric element respectively and N is the number of modes. C_p and α_i are obtainable from the following equations[22]:

$$\alpha_i = -d_{31} c_{11}^E b h_p \int_0^{l_p} \phi_i^{nT}(x) dx \quad (3)$$

$$C_p = \frac{\epsilon_{33}^S A_p}{t_p} \quad (4)$$

where c_{11}^E is Young's modulus in the x-axis direction of the piezoelectric layer under constant electric field and ϵ_{33}^S is the permittivity of the piezoelectric layer in the y-axis direction (Fig. 1) under constant strain. d_{31} is the piezoelectric strain constant. A_p and t_p are the surface area perpendicular to the y axis and the thickness of the piezoelectric layer, respectively. h_p is the distance from the centroid of the piezoelectric layer to the neutral axis, l_p is the piezoelectric layer length and b is the width of the beam.

In piezoelectric materials, a considerable portion of converted energy will be stored on the internal capacitor of the piezoelectric patch and a minor portion will be dissipated in the load resistor. Considering I_{out} in Eq. (2), the second term is the stored portion of current on the piezoelectric internal capacitor. By extracting more from the stored portion, more energy will be dissipated and better damping is obtainable. In earlier methods, connecting different RLC networks to mounted piezoelectric, results in piezoelectric electrostatic field magnitude reduction, more energy extraction, more energy dissipation and more vibration damping, consequently. In the mentioned methods, the electrostatic field is reduced (not eliminated) and a bigger portion (not whole) of the stored energy is extracted. In this paper, using the proposed multi-switch network and RLC resonance concept, the electrical resonance condition is satisfied in a wide frequency range and electrostatic field is eliminated (not reduced) and the whole converted energy (not a portion) is extracted. Therefore, an effective and broadband shunt damping is obtainable.

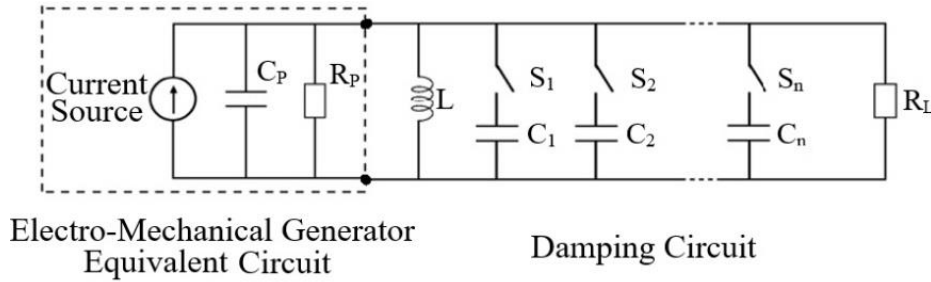

Fig. 2. Equivalent circuit of the electro-mechanical generator.

The equivalent circuit of the electro-mechanical generator represented in Fig. 1 is shown in Fig. 2, which is an AC source in parallel with the internal capacitor (C_p) and resistor (R_p) of the piezoelectric element (Kong *et al.*[23]. In this RLC circuit, if the reactance of the equal capacitor (equivalent of C_p , C_1 , C_2 , ..., C_n) and the inductor (L) are equal in magnitude, electrical resonance occurs and results in a purely resistive impedance circuit. In this case, no electrical energy will be stored in the electrostatic field of the piezoelectric element (Hayt *et al.*)[24] and the second term of Eq. (2) will be zero theoretically, which maximizes the extracted energy from piezoelectric and dissipated energy in the load resistor (R_L) and resulted in damping consequently.

The reactance of the capacitors (X_C) and the inductor (X_L) are as the following:

$$X_C = \frac{1}{\omega(C_p + C)} = \frac{1}{2\pi f(C_p + C)}, \quad X_L = \omega L = 2\pi f L \quad (5)$$

where C and L are the capacitance and inductance of the damping circuit. ω and f are the frequency in terms of rad/s and Hz, respectively. If X_C and X_L be equal in magnitude, the electrical resonance frequency will be (Hayt *et al.*[24]):

$$f_R = \frac{1}{2\pi\sqrt{L(C_p + C)}} \quad (6)$$

When the mechanical excitation frequency is equal to the electrical resonance frequency, the RLC circuit eliminates the reactance of the piezoelectric element ($1/\omega.C_p$). The mechanical excitation frequency is environmental and out of control, therefore the circuit resonance frequency should be adaptive with vibration frequency to resonate the circuit for any excitation in a wide frequency range. The proposed smart multi-switch capacitor network changes the capacitance of the circuit to satisfy Eq. (6) and keep the circuit in resonance condition for any vibration frequency.

3. Multi-switch damping circuit modeling

Considering the circuit shown in Fig. 2, by selecting suitable inductor and capacitor satisfying Eq. (6), resonance occurs and the whole converted energy can be extracted and dissipated in the load resistor. The magnitude of active elements of the proposed adaptive damping circuit must be changed proportionally to the frequency changes to satisfy Eq. (6) which results in resonance in all frequencies. The circuit of Fig. 2, is a multi-switch damping circuit with an adaptive capacitor to resonate in all frequencies, in which S_i and C_i are the electronic switches and constant capacitors respectively. In this circuit, a number of capacitors and switches are in parallel with a constant inductor and the equivalent circuit of the generator. In order to satisfy Eq. (6), by opening and closing appropriate switches according to the frequency variations, resonance condition can be kept in the circuit, consequently, maximum energy can be extracted from the mechanical structure and maximum damping is obtainable.

The number of switches (n) is very important in circuit design. Using a few switches results in low accuracy in circuit performance. On the other hand, by increasing the number of switches, circuit losses will be increased. Therefore, an optimum number of switches should be selected to keep high accuracy and low power losses simultaneously. Capacitors' magnitudes are arranged based on Eq. (7). Therefore, the switches have 2^n different states and with only n capacitors, 2^n capacitors with different capacitances can be obtained.

$$\begin{cases} C_1 \\ C_2 = C_1 \times 2^1 \\ C_3 = C_1 \times 2^2 \\ \vdots \\ C_n = C_1 \times 2^{n-1} \end{cases} \quad (7)$$

The vibration frequency should be measured continuously from displacement signal analysis and after sensing any changes in the frequency, by considering constant elements of the circuit (C_p and L), Eq. (6) should be derived and necessary capacitance should be calculated. Then, by automatically closing and opening suitable switches (using a microcontroller), the desired capacitance can be provided in the circuit. The measurement and calculation stages are shown schematically in Fig. 3.

As shown in this figure, the displacement signal of the vibrating piezoelectric is the input of the frequency measurement stage. Then, the measured vibration period (T) goes into the calculation block to calculate the necessary capacitance. The calculation result is in binary form (S_C) with n bits (n is the number of switches) that controls the circuit switches. Each bit of S_C goes to a single switch to close or open it and the total capacitance of the harvesting circuit is $C = S_C.C_1$. Substituting f by $1/T$ and C by $S_C.C_1$ in Eq. (6), results in S_C formula as the following:

$$S_C = \text{round}\left(\left(\frac{T^2}{4\pi^2 L} - C_p\right) / C_1\right), S_C = 0,1,2,3,\dots,2^n - 1 \tag{8}$$

The frequency range of the proposed harvesting circuit depends on C_P , L , C_1 and n and the boundary frequencies are as the following:

$$f_{\min} = \frac{1}{2\pi\sqrt{L(C_p + C_1 \times 2^n)}}, f_{\max} = \frac{1}{2\pi\sqrt{LC_p}} \tag{9}$$

The final multi-switch damping circuit with its logical calculation part has been shown in detail in Fig. 4.

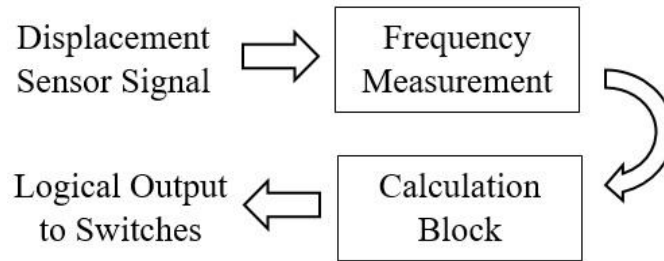

Fig. 3. Schematic of the logical calculations in the adaptive multi-switch technique.

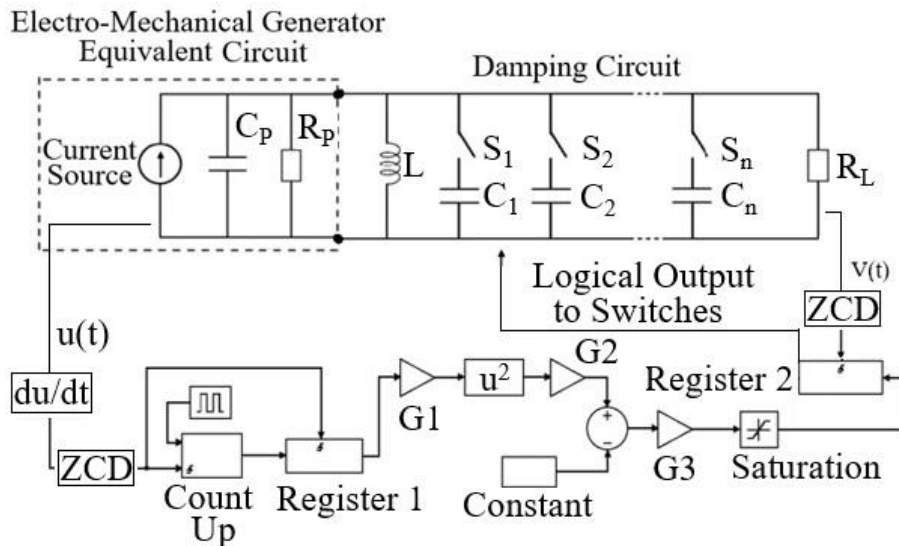

Fig. 4. Final circuit of adaptive multi-switch damping technique with logical calculation blocks.

One of the most important parts of the circuit is the frequency measurement block which calculates precisely and continuously the vibration frequency. The displacement signal $u(t)$ of vibrating piezoelectric enters the du/dt block, then enters the zero crossing detector (ZCD) and the output is a digital square signal [25]. This square signal is the activator of Register1 which is sensitive to the rising edge of the signal and also resets the Count up block by its rising edge. The Count up block is an increment type counter and its clock port is connected to a digital oscillator with period T_0 (10^{-5} s) which is too much smaller than the mechanical vibration period. The Count up block counts the relative period of the square signal to the oscillator signal and the result goes into Resister 1. Multiplying the relative period to T_0 in G_1 results in the vibration period with $\pm T_0$ tolerance. The next step is the S_C calculation based on Eq. (8). The squared measured period (T^2) is multiplied to $1/4\pi^2L$ in G_2 . Then, C_P is subtracted using Constant block and the result is divided into C_I in G_3 . Then, the calculated S_C goes into the saturation block. The harvesting circuit has been designed to work in the frequency range between f_{min} and f_{max} (Eq. (9)). Thus, in order to have better performance in the frequencies lower than f_{min} and upper than f_{max} , S_C should be saturated in the domain of $[0, 2^n-1]$ using a saturation block. Finally, the obtained binary number of S_C on Register 2 should wait until the circuit voltage becomes zero and then, goes to the switches to update their condition.

4. Damping strategy for non-harmonic vibrations

For harmonic excitations (especially with resonance frequencies) in a vibrating structure, system displacement is harmonic and single frequency. But, when the excitation is random or a combination of some modulated signals, system displacement is a combination of harmonic signals with mechanical resonance frequencies of the structure[26]. In this case, the zero crossing detector block of the circuit detects a square signal with the main frequency of the response which has the biggest amplitude and power in the system response and this frequency is the base of calculations in the logical part of the circuit. A random signal with the corresponding square signal which is detected by ZCD block is shown in Fig. 5. The detected square signal by ZCD block.

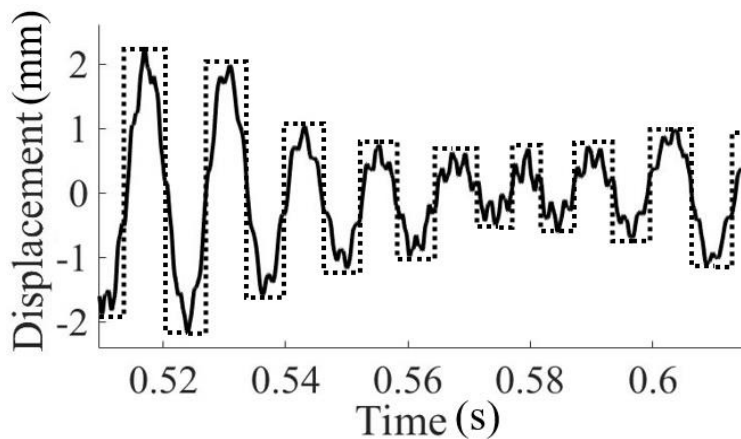

Fig. 5. Detected square signal by ZCD block for a random signal.

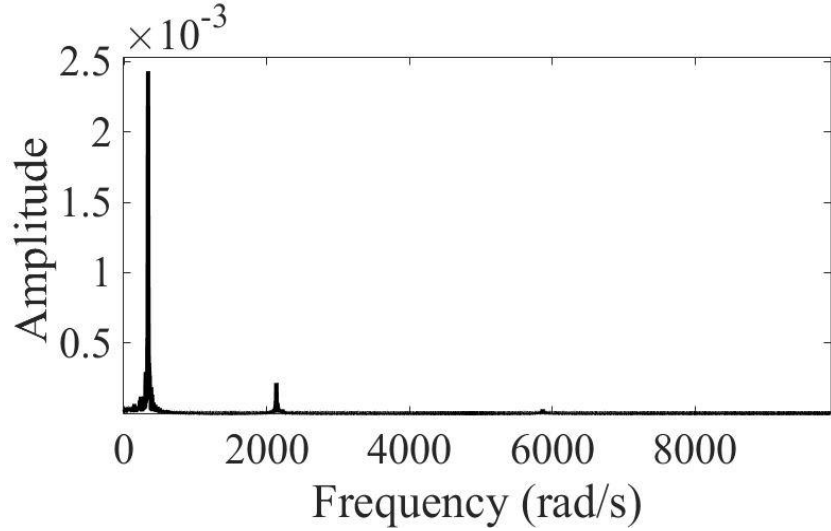

Fig. 6. FFT plot for the random signal shown in Fig. 5.

The corresponding FFT (Fast Fourier Transform) plot of the mentioned random signal is shown in Fig. 6. As shown in these figures, ZCD block detects the main and most powerful frequency with the most amplitude in FFT transform as the base of S_C calculation to have the best damping.

5. Damping evaluation

In order to study method performance, the following evaluation technique (Eqs. (10) and (11)) is described, in which controlled and uncontrolled vibrations are compared together. The used quantity is related to mechanical deflection. This quantity I_u , is a summation in the time variable for the considered modes and is the mean squared response of $u(x, t)$, which is defined as (Mohammadi et al.)[27]:

$$I_u = \overline{u(x,t)^2} = \lim_{\tau \rightarrow \infty} \left(\frac{1}{\tau} \int_0^{\tau} u^2(x,t) dt \right) = \sum_i \sum_k \left[\varphi_i(x) \varphi_k(x) \lim_{\tau \rightarrow \infty} \left(\frac{1}{\tau} \int_0^{\tau} q_i(t) q_k(t) dt \right) \right] \quad (10)$$

Eq. (10) is used once to calculate controlled I_u and another time to calculate uncontrolled I_u . At first, controlled $u(x,t)$ is inserted in the equation and then, $u(x,t)$ in an uncontrolled vibration situation is calculated and inserted in Eq. (10). Using the results of this equation, The displacement damping A_u is then evaluated as (Mohammadi et al.,[27]):

$$A_u = 10 \log \left(\frac{(I_u)_{\text{controlled}}}{(I_u)_{\text{uncontrolled}}} \right) \quad (11)$$

6. Numerical results

The numerical model consists of an aluminum cantilever beam equipped with a piezoelectric layer on one side under an external excitation at the free end of the beam (Fig. 1). Piezoelectric electrodes are connected to the adaptive multi-switch damping circuit (Fig. 4). The logical block of the damping circuit detects vibration frequency in harmonic vibrations and the main frequency (most powerful frequency) in random vibrations. Then, based on the calculated frequency, the necessary capacitance to keep electrical resonance is calculated by the logical block which updates the condition of electronic switches. The model is simulated by MATLAB software and the motion equation is solved using the fourth-order Runge-Kutta algorithm. The mechanical, physical and electrical characteristics of the model are shown in Table 1.

Table 1. Characteristics of the model.

Beam Material and Dimensions (mm)	Aluminum, 180×90×2
Piezoelectric Material and Dimensions (mm)	PZT-4, 90×40×0.3
Beam Young's modulus (GPa)	70 [28](Beer <i>et al.</i>)
d_{31} (m/V)	122×10^{-12} (Plagianakos and Saravanos, 2003)[29]
c_{11}^E (GPa)	81.3 (Plagianakos and Saravanos, 2003)[29]
ϵ_{33}^S (F/m)	11505×10^{-12} (Plagianakos and Saravanos, 2003)[29]
C_p (nF)	138 (calculated from Eq. (4))
C_l (nF)	80
L (H)	0.4
R_L (k Ω)	50
n	8
f_{min}, f_{max} (Hz)	55, 680 (calculated from Eq. (9))

Harmonic excitations with the frequencies corresponding to the first two natural modes of the equipped beam (78Hz, 495Hz) and also non-stationary random excitation with 1N amplitude are applied to the free end of the beam and the results are presented in the Figs. 7 to 10. In these figures, the proposed technique results are compared with standard passive technique, in which piezoelectric electrodes are directly connected to a load resistor.

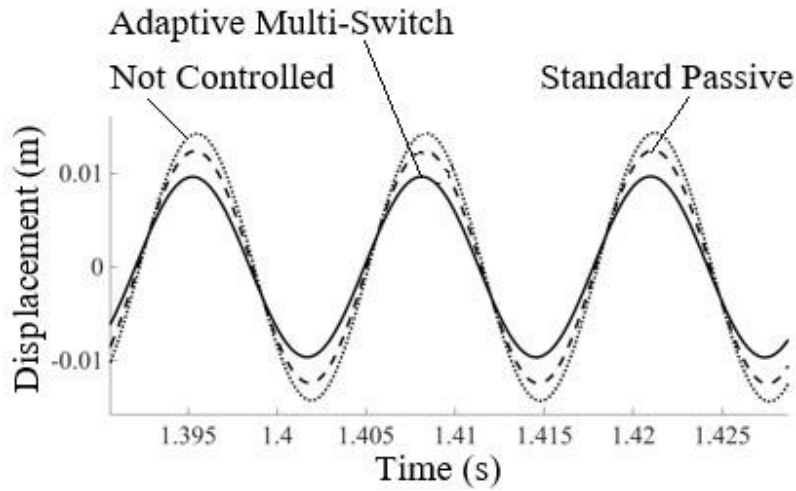

Fig. 7. Free end deflection of the beam under harmonic excitation with the 1st resonance frequency (78 Hz), not controlled \cdots , Standard passive controlled $-\cdots-$, Controlled by adaptive multi-switch technique — .

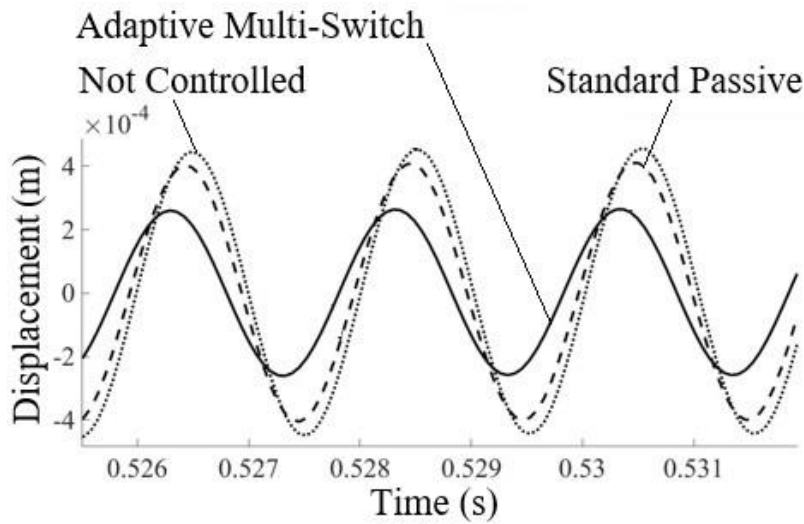

Fig. 8. Free end deflection of the beam under harmonic excitation with the 2nd resonance frequency (495 Hz), not controlled \cdots , Standard passive controlled $-\cdots-$, Controlled by adaptive multi-switch technique — .

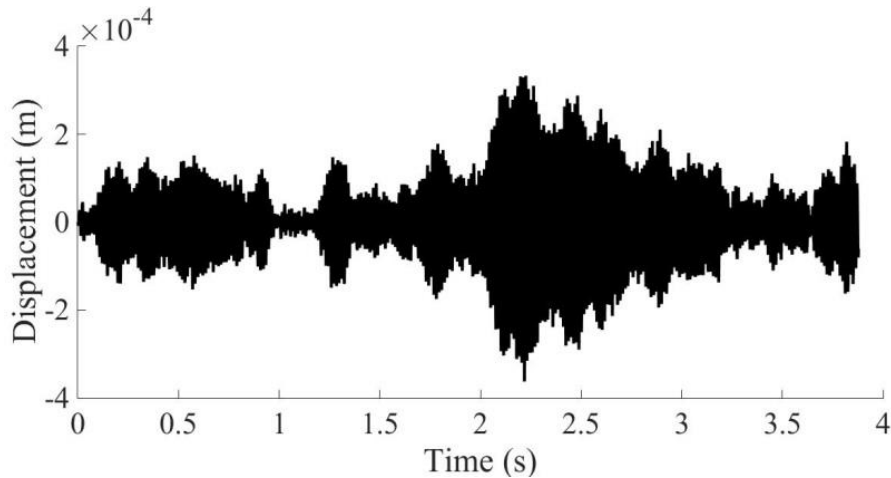

Fig. 9. Uncontrolled displacement of the free end of the beam under non-stationary random excitation.

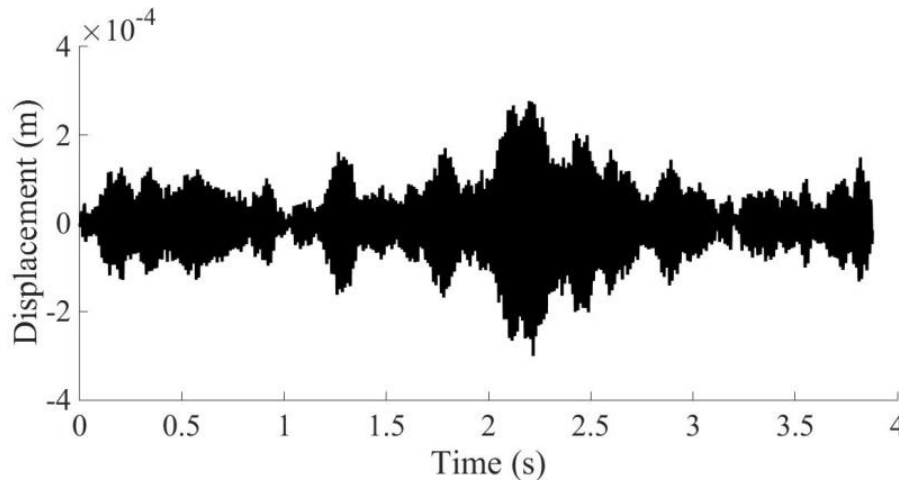

Fig. 10. Free end displacement of the beam under non-stationary random excitation, controlled by an adaptive multi-switch damping circuit.

Resulted damping calculated by Eqs. (10) and (11) for harmonic excitations with the 1st and 2nd natural frequencies and also random excitation using the proposed technique are 2.65, 4.18 and 2.3 times more than standard passive damping, respectively.

7. Conclusion

Piezoelectric shunt vibration dampers are interesting for researchers in comparison with traditional approaches. Recent shunt dampers are not self-tuning for different mechanical situations of the structure during operation, do not provide high damping and don't have acceptable performance especially in high frequencies. In order to cover weaknesses of earlier shunt dampers, a new semi-active adaptive multi-switch RLC shunt damper using piezoelectric elements is proposed in this paper. This circuit is designed as a multi-modal vibration damper to control any type of vibration such as harmonic, random, etc. The proposed circuit consists of a series of switch-capacitor sets and also an inductor connected to a vibrating piezoelectric. Using the proposed network, self-tuning ability provides electrical resonance in the circuit for both

harmonic and random excitations in the design frequency range of the circuit and also any mass and stiffness of the structure. Therefore, electrical resonance occurs in any mechanical operational situation and almost the whole converted energy by piezoelectric element is extracted from the piezoelectric electrostatic field and is dissipated in the load resistor. In recent methods, the electrostatic field of piezoelectric elements is reduced (not eliminated) and a portion (not whole) of the stored energy is extracted and dissipated in the resistor. In this paper, using the proposed multi-switch network and RLC resonance concept, theoretically, the electrostatic field of piezoelectric is eliminated (not reduced) and almost the whole converted energy (not a portion) is extracted and dissipated in the load resistor, in the design frequency range of the circuit. The resulted damping using the proposed method for the 1st mode, 2nd mode and random excitation are 2.65, 4.18 and 2.3 times more than standard passive technique. Finally, the proposed adaptive multi-switch damping circuit provides significant damping in both low and high frequencies (in the design frequency range of the circuit) in any mechanical and operational situation of the system (mass variations, stiffness variations, excitation frequency changes, etc.) for almost all excitation types.

References

- [1] Z. Jiang, R.E. Christenson, A fully dynamic magneto-rheological fluid damper model, *Smart Materials and Structures*, 21 (2012) 065002.
- [2] G. Song, V. Sethi, H.-N. Li, Vibration control of civil structures using piezoceramic smart materials: A review, *Engineering Structures*, 28 (2006) 1513-1524.
- [3] A.R. Damanpack, M. Bodaghi, M.M. Aghdam, M. Shakeri, On the vibration control capability of shape memory alloy composite beams, *Composite Structures*, 110 (2014) 325-334.
- [4] B. Ebrahimi, M.B. Khamesee, F. Golnaraghi, Eddy current damper feasibility in automobile suspension: modeling, simulation and testing, *Smart Materials and Structures*, 18 (2008) 015017.
- [5] F. Peng, A. Ng, Y.-R. Hu, Actuator placement optimization and adaptive vibration control of plate smart structures, *Journal of Intelligent Material Systems and Structures*, 16 (2005) 263-271.
- [6] K. Ma, M.N. Ghasemi-Nejhad, Adaptive control of flexible active composite manipulators driven by piezoelectric patches and active struts with dead zones, *IEEE transactions on control systems technology*, 16 (2008) 897-907.
- [7] R.L. Forward, Electronic damping of vibrations in optical structures, *Applied optics*, 18 (1979) 690-697.
- [8] J.J. Hollkamp, Multimodal passive vibration suppression with piezoelectric materials and resonant shunts, *Journal of intelligent material systems and structures*, 5 (1994) 49-57.
- [9] S.-y. Wu, Method for multiple-mode shunt damping of structural vibration using a single PZT transducer, in: *Smart structures and materials 1998: passive damping and isolation*, International Society for Optics and Photonics, 1998, pp. 159-168.
- [10] M.S. Tsai, K.W. Wang, On the structural damping characteristics of active piezoelectric actuators with passive shunt, *Journal of Sound and Vibration*, 221 (1999) 1-22.
- [11] R.A. Morgan, K.W. Wang, Active-passive piezoelectric absorbers for systems under multiple non-stationary harmonic excitations, *Journal of sound and vibration*, 255 (2002) 685-700.
- [12] M. Date, M. Kutani, S. Sakai, Electrically controlled elasticity utilizing piezoelectric coupling, *Journal of Applied Physics*, 87 (2000) 863-868.
- [13] H. Kodama, T. Okubo, M. Date, E. Fukada, Sound reflection and absorption by piezoelectric polymer films, in: *Materials Research Society Symposium Proceedings*, Warrendale, Pa.; Materials Research Society; 1999, 2002, pp. 43-52.
- [14] P. Mokry, E. Fukada, K. Yamamoto, Sound absorbing system as an application of the active elasticity control technique, *Journal of Applied Physics*, 94 (2003) 7356-7362.
- [15] E. Fukada, M. Date, K. Kimura, T. Okubo, H. Kodama, P. Mokry, K. Yamamoto, Sound isolation by piezoelectric polymer films connected to negative capacitance circuits, *IEEE Transactions on Dielectrics and Electrical Insulation*, 11 (2004) 328-333.

- [16] K. Imoto, M. Nishiura, K. Yamamoto, M. Date, E. Fukada, Y. Tajitsu, Elasticity control of piezoelectric lead zirconate titanate (PZT) materials using negative-capacitance circuits, *Japanese journal of applied physics*, 44 (2005) 7019.
- [17] K. Tahara, H. Ueda, J. Takarada, K. Imoto, K. Yamamoto, M. Date, E. Fukada, Y. Tajitsu, Basic study of application for elasticity control of piezoelectric lead zirconate titanate materials using negative-capacitance circuits to sound shielding technology, *Japanese journal of applied physics*, 45 (2006) 7422.
- [18] S. Behrens, S.O.R. Moheimani, Current flowing multiple-mode piezoelectric shunt dampener, in: *Smart structures and materials 2002: damping and isolation*, International Society for Optics and Photonics, 2002, pp. 217-226.
- [19] A. Preumont, B. De Marneffe, A. Deraemaeker, F. Bossens, The damping of a truss structure with a piezoelectric transducer, *Computers & structures*, 86 (2008) 227-239.
- [20] A.L. Goldstein, Self-tuning multimodal piezoelectric shunt damping, *Journal of the Brazilian Society of Mechanical Sciences and Engineering*, 33 (2011) 428-436.
- [21] D. Guyomar, C. Richard, S. Mohammadi, Semi-passive random vibration control based on statistics, *Journal of Sound and Vibration*, 307 (2007) 818-833.
- [22] L. Wang, *Vibration energy harvesting by magnetostrictive materials for powering wireless sensors*, in, Ph.D. Thesis. North Carolina State University. USA., 2007.
- [23] N.A. Kong, D.S. Ha, A. Erturk, D.J. Inman, Resistive impedance matching circuit for piezoelectric energy harvesting, *Journal of Intelligent Material Systems and Structures*, 21 (2010) 1293-1302.
- [24] W.H. Hayt, J.E. Kemmerly, S.M. Durbin, *Engineering circuit analysis*, McGraw-Hill New York, 2012.
- [25] S. Mehraeen, S. Jagannathan, K.A. Corzine, Energy harvesting from vibration with alternate scavenging circuitry and tapered cantilever beam, *IEEE Transactions on Industrial Electronics*, 57 (2009) 820-830.
- [26] S.S. Rao, *Mechanical Vibrations*, Pearson, London, 2017.
- [27] S. Mohammadi, S. Hatam, A. Khodayari, Modeling of a hybrid semi-active/passive vibration control technique, *Journal of Vibration and Control*, 21 (2015) 21-28.
- [28] F. Beer, E. Johnston, D. Mazurek, *Mecânica dos Materiais-7ª Edição*, McGraw-Hill, New York, 2015.
- [29] D. Saravanos, T. Plagianakos, Hybrid Damped Composite Plates with Viscoelastic Composite Plies and Shunted Piezoelectric Layers, in: *43rd AIAA/ASME/ASCE/AHS/ASC Structures, Structural Dynamics, and Materials Conference*, 2002, pp. 1364.